

Engine Immobiliser System

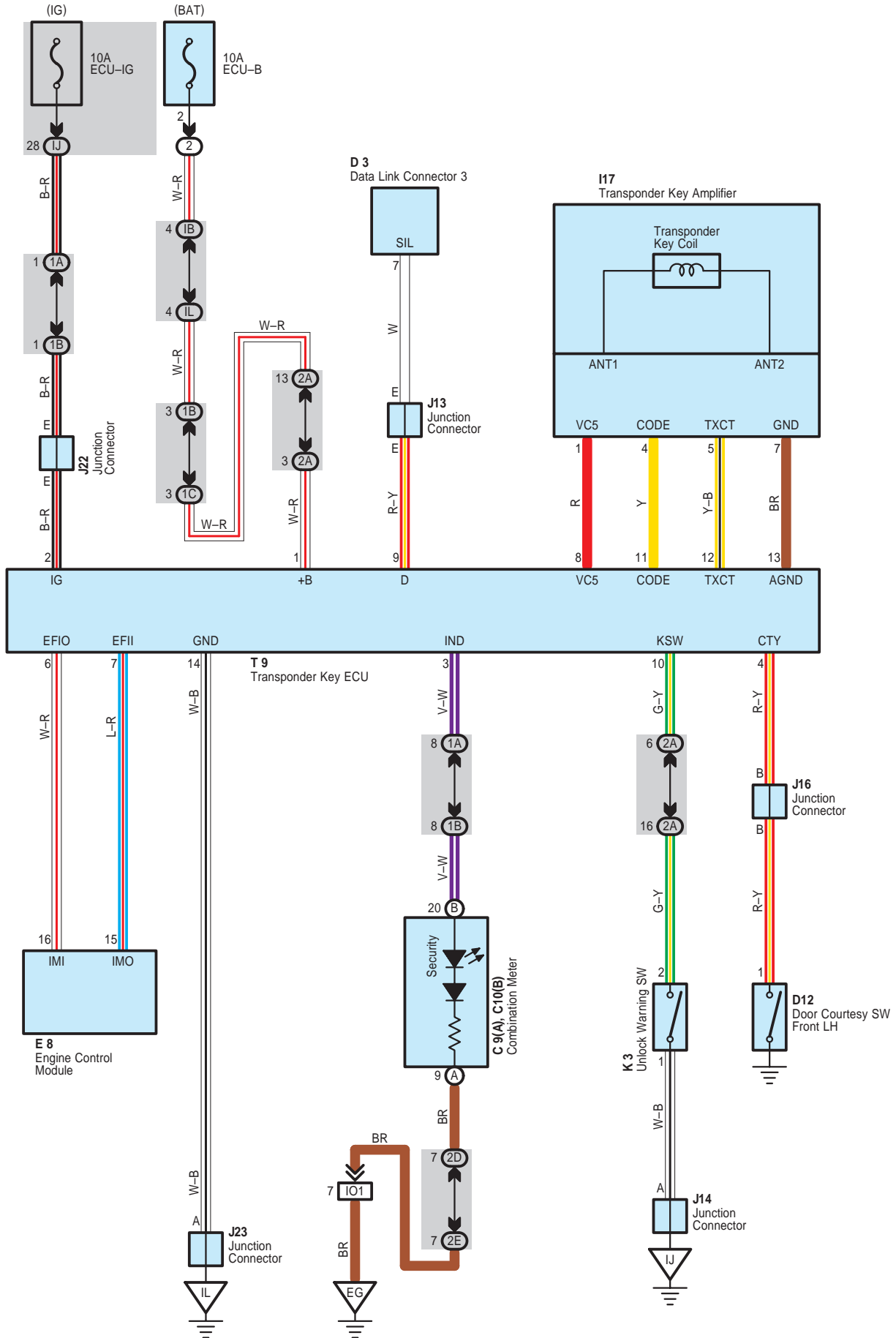

Engine Immobiliser System

C 9
White

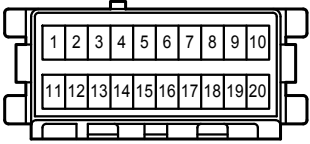

C 10
White

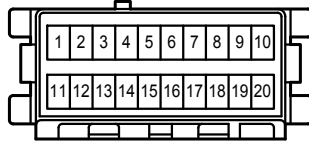

D 3
White

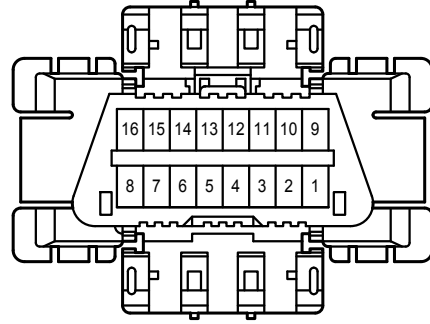

D 12
Black



E 8
White

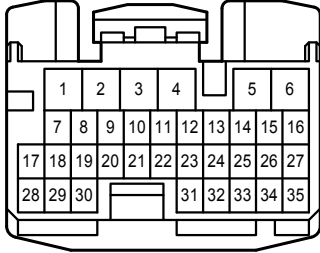

I 17
Black

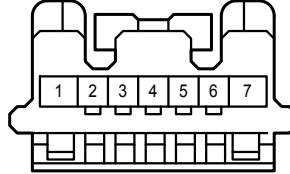

J 13
White

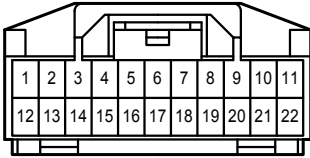

J 14
White

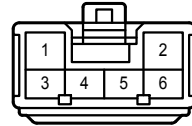

J 16
White

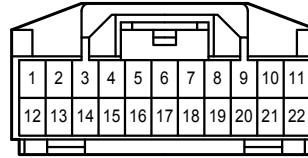

J 22
White

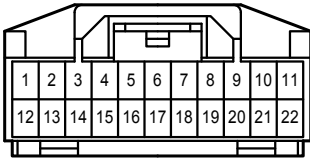

J 23
White

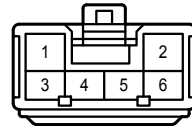

K 3
White

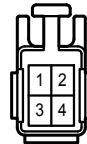

T 9
White

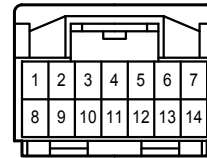

1A
White

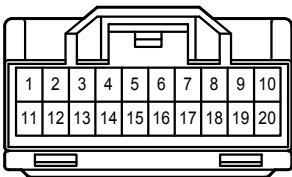

1B
Black

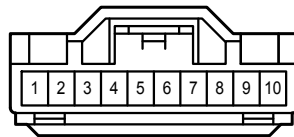

1C
White

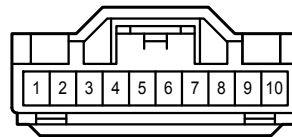

2A
White

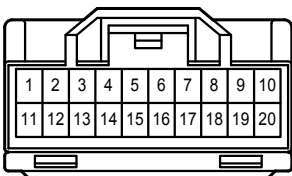

2D
Black

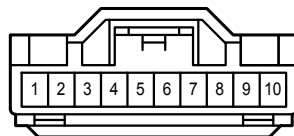

2E
White

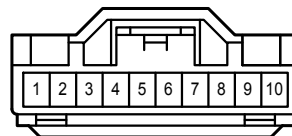

Engine Immobiliser System

IB
White

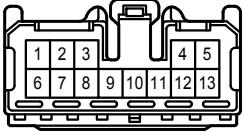

IJ
White

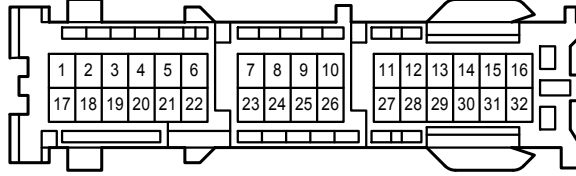

IL
White

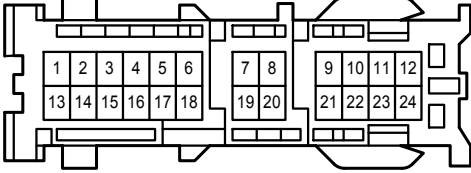

IO1
White

